

PRICE \$2.00

HEATH COMPANY • BENTON HARBOR, MICHIGAN

HEATHKIT® ASSEMBLY MANUAL



REGULATED LOW VOLTAGE POWER SUPPLY MODEL IP-27

595-859-04











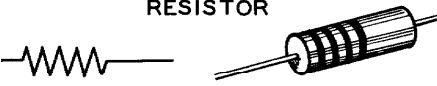
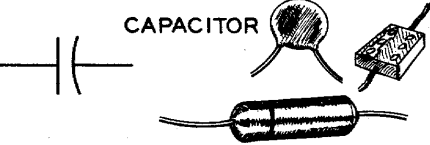
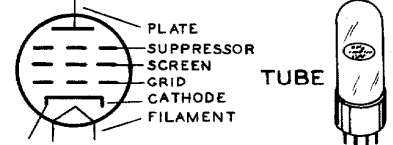
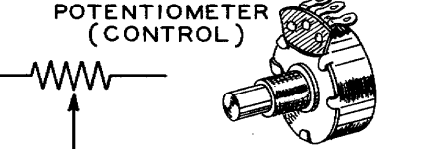
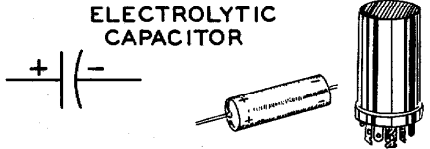

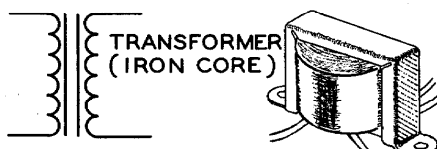
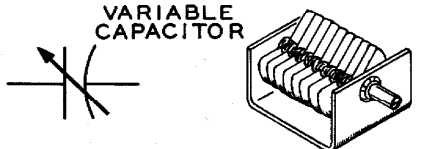
Copyright © 1967
Heath Company
All rights reserved

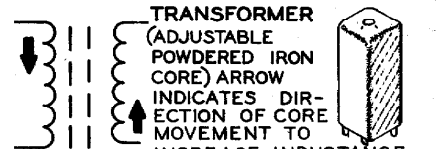
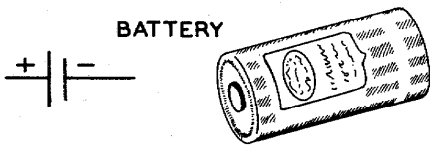
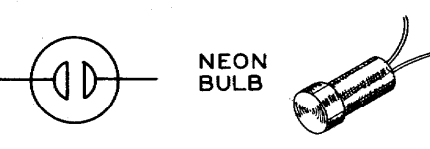
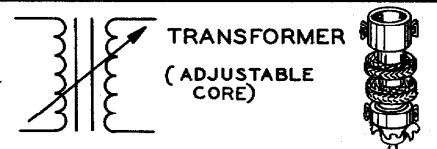
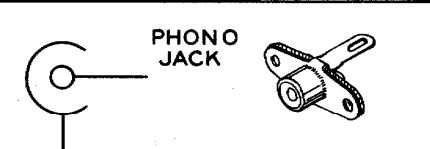
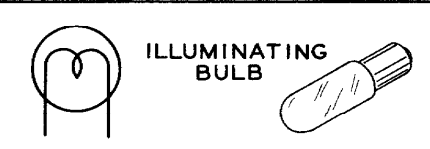
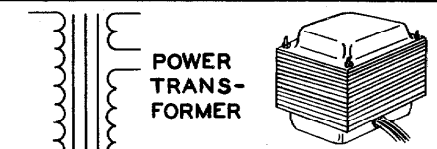
TYPICAL COMPONENT TYPES

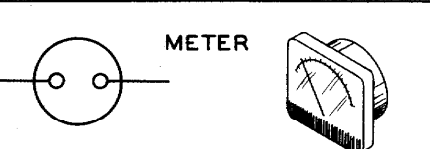
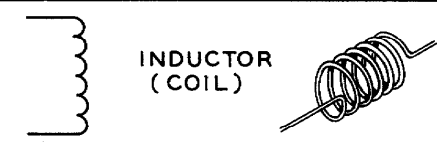
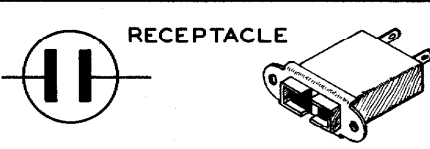
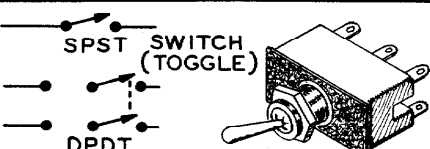
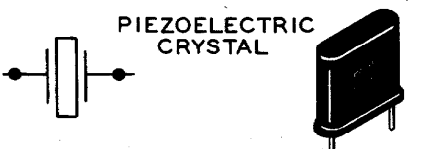
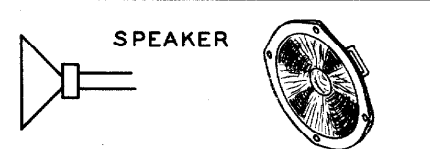
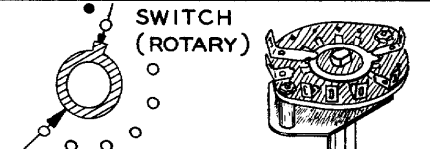
This chart is a guide to commonly used types of electronic components. The symbols and related illustrations

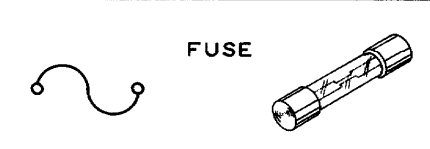
should prove helpful in identifying most parts and reading the schematic diagrams.

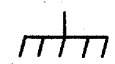
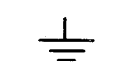
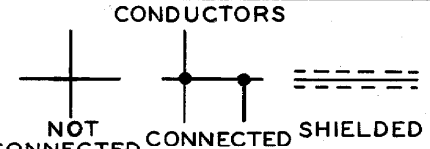
<p style="text-align: center;">RESISTOR</p> 	<p style="text-align: center;">CAPACITOR</p> 	<p style="text-align: center;">TUBE</p> 
<p style="text-align: center;">POTENTIOMETER (CONTROL)</p> 	<p style="text-align: center;">ELECTROLYTIC CAPACITOR</p> 	<p style="text-align: center;">TRANSISTOR</p> 
<p style="text-align: center;">TRANSFORMER (IRON CORE)</p> 	<p style="text-align: center;">VARIABLE CAPACITOR</p> 	<p style="text-align: center;">RECTIFIER (DIODE)</p> 
<p style="text-align: center;">TRANSFORMER (ADJUSTABLE POWDERED IRON CORE) ARROW INDICATES DIRECTION OF CORE MOVEMENT TO INCREASE INDUCTANCE</p> 	<p style="text-align: center;">BATTERY</p> 	<p style="text-align: center;">NEON BULB</p> 
<p style="text-align: center;">TRANSFORMER (ADJUSTABLE CORE)</p> 	<p style="text-align: center;">PHONO JACK</p> 	<p style="text-align: center;">ILLUMINATING BULB</p> 
<p style="text-align: center;">POWER TRANSFORMER</p> 	<p style="text-align: center;">PHONE JACK</p> 	<p style="text-align: center;">METER</p> 
<p style="text-align: center;">INDUCTOR (COIL)</p> 	<p style="text-align: center;">RECEPTACLE</p> 	<p style="text-align: center;">SWITCH (TOGGLE)</p> 
<p style="text-align: center;">PIEZOELECTRIC CRYSTAL</p> 	<p style="text-align: center;">SPEAKER</p> 	<p style="text-align: center;">SWITCH (ROTARY)</p> 
<p style="text-align: center;">BINDING POST</p> 	<p style="text-align: center;">MICROPHONE</p> 	<p style="text-align: center;">FUSE</p> 
<p style="text-align: center;">ANTENNA</p>  <p style="text-align: center;">GENERAL LOOP</p>	<p style="text-align: center;">EARTH GROUND</p>  <p style="text-align: center;">CHASSIS GROUND</p> 	<p style="text-align: center;">CONDUCTORS</p>  <p style="text-align: center;">NOT CONNECTED CONNECTED SHIELDED</p>

Assembly
and
Operation
of the



**REGULATED
LOW VOLTAGE
POWER SUPPLY**

Model IP-27

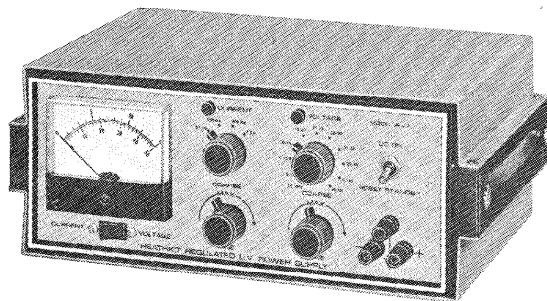

TABLE OF CONTENTS

Introduction.	2
Parts List.	3
Step-By-Step Assembly	
Rotary Switch Prewiring.	6
Front Panel Assembly And Wiring.	9
Rear Panel Assembly.	14
Chassis Parts Mounting.	18
Chassis Assembly.	20
Bottom Of Chassis Wiring.	22
Top Of Chassis Wiring.	24
Final Wiring.	26
Knob Installation.	29
Initial Tests And Adjustments.	30
Final Assembly.	34
Operation.	36
In Case Of Difficulty.	40
Factory Repair Service.	40
Troubleshooting Chart.	41
Specifications.	42
Theory Of Operation.	42
Circuit Description.	44
Replacement Parts Price List.	48
Schematic. . . (fold-out from page).	51

HEATH COMPANY
BENTON HARBOR, MICHIGAN 49022



INTRODUCTION

The Heathkit Model IP-27 Regulated Low Voltage Power Supply is a convenient source of low voltage DC power. It will furnish DC voltages between .5 and 50 volts, and DC current up to 1.5 amperes. The large front panel meter can be switched to measure either the output voltage or the output current; indicator lights show which function is being monitored.

Output voltage is selected in 5-volt increments by the Coarse Voltage switch, and vernier adjustments can be made with the Fine Voltage control. Output current limiting is also selected in fixed ranges by the Coarse Current switch, and the Fine Current control is used for vernier adjustments.

Output is taken from the positive (+) and negative (-) front panel binding posts, which are completely isolated from the chassis. A separate binding post is provided for making connections to the chassis. The Power Supply is protected against overloads by the automatic current limiter and the overload relay circuits.

The Power Supply is designed to match other Heathkit equipment lines in practical, low-profile styling, including feet for convenient stacking, and handles on each side of the cabinet for portability. The cabinet surface is easily cleaned with soap and water. Since all regulation and calibration controls are on the rear panel, they are accessible without removing the cover.

Other features include: Meter scales that are color matched to the Coarse Voltage and Current range switch markings; the latest features in solid-state circuitry for cool, dependable operation; and four-step current limiting, covering a range of 50 milliamperes to 1.5 amperes. Higher output capabilities can also be obtained by connecting additional IP-27 Power Supplies in series or parallel. The attractive styling of this Power Supply and the excellent regulation make it an ideal instrument for both the laboratory and the modern repair shop.

Refer to the "Kit Builders Guide" for complete information on unpacking, parts identification, tools, wiring, soldering, and step-by-step assembly procedures.

PARTS LIST

The numbers in parentheses are keyed to the numbers on the Parts Pictorial (fold-out from Page 5).

To order replacement parts, refer to the Replacement Parts Price List and use the Parts Order Form furnished with this kit.

PART No.	PARTS Per Kit	DESCRIPTION	PART No.	PARTS Per Kit	DESCRIPTION
RESISTORS			Other Resistors		
1/2 Watt 10%			(5) 3-1-5	1	2500 Ω 5% 7 watt wire-wound resistor
(1) 1-41	2	10 Ω (brown-black-black)	(6) 9-9	1	500 Ω thermistor
1-13	1	2700 Ω (red-violet-red)	CAPACITORS		
1-16	1	4700 Ω (yellow-violet-red)	(7) 21-16	1	.01 μ fd disc
1-23	2	27 K Ω (red-violet-orange)	(8) 27-34	1	.2 μ fd resin
1-27	1	150 K Ω (brown-green-yellow)	(9) 25-56	1	100 μ fd electrolytic, 10 V
1/2 Watt 5%			(10) 25-128	1	100 μ fd electrolytic, 50 V
1-130	1	8.2 Ω (gray-red-gold)	(11) 25-131	1	250 μ fd electrolytic, 25 V
1-54	2	15 Ω (brown-green-black)	(12) 25-121	1	500 μ fd electrolytic, 50 V
1-136	2	160 Ω (brown-blue-brown)	(13) 25-177	1	3000 μ fd electrolytic, 75 V
1-137	18	200 Ω (red-black-brown)	(14) 25-178	1	100-40-40 μ fd electrolytic
1-80	2	1200 Ω (brown-red-red)	WIRE-WOUND CONTROLS		
2 Watt 10%			(15) 11-77	1	30 Ω
(2) 1-19-2	1	1200 Ω (brown-red-red)	11-76	1	240 Ω
1-17-2	1	6800 Ω (blue-gray-red)	(16) 11-74	1	50 Ω
2 Watt 5%			11-44	2	1000 Ω
(3) 3-2-2*	3	.33 Ω (orange-orange-silver-gold)	SWITCHES		
3-1-2	1	.82 Ω (gray-red-silver-gold)	(17) 63-437	1	4-position 2-wafer rotary
3-3-2	1	2.7 Ω (red-violet-gold-gold)	(18) 63-438	1	11-position 4-wafer rotary
*NOTE: These resistors are 2 watt wire-wound resistors, but are the same size as 1 watt composition resistors.			(19) 60-20	1	TPDT slide
Precision 1/2 Watt 1%			(20) 60-34	1	TPDT rocker
(4) 2-94	1	.1 Ω	(21) 61-9	1	SPST toggle (with two 1/2" nuts and a lockwasher)
2-130	1	.2 Ω	TRANSISTORS-DIODES		
2-163	1	.7 Ω	(22) 417-20	2	2N2553/R265A/2N1039-1 transistor
2-229	1	2.0 Ω	(23) 417-141	2	2N2869/2N301 transistor
2-259	1	97 Ω	417-142	1	DTG-600 transistor
2-165	1	4950 Ω	(24) 57-27	8	Silicon diode
2-50	1	10 K Ω	(25) 56-13	1	56 V zener diode
2-166	1	35 K Ω	56-68	1	68 V zener diode
			(26) 56-48	1	110 V zener diode



<u>PART No.</u>	<u>PARTS Per Kit</u>	<u>DESCRIPTION</u>
-----------------	----------------------	--------------------

<u>PART No.</u>	<u>PARTS Per Kit</u>	<u>DESCRIPTION</u>
-----------------	----------------------	--------------------

SOCKETS-TERMINAL STRIPS-FUSEHOLDER

(27)434-102	2	Small transistor socket
(28)434-117	3	Large transistor socket
(29)431-50	1	1-lug terminal strip
(30)431-51	1	2-lug terminal strip
(31)431-41	1	2-lug terminal strip
(32)431-5	2	4-lug terminal strip
(33)431-11	1	5-lug terminal strip
(34)431-45	2	6-lug terminal strip
(35)431-35	1	7-lug terminal strip
(36)422-1	1	Fuseholder

Wire Harness-Wire-Sleeving (cont'd.)

344-52	1	Small red wire
344-54	1	Small yellow wire
344-56	1	Small blue wire
340-2	1	Bare wire
346-1	1	Sleeving

HARDWARE**#2 Hardware**

(42)250-175	11	2-56 x 3/8" screw
(43)254-7	11	#3 lockwasher
(44)252-51	11	2-56 nut

#6 Hardware

(45)250-229	8	6-32 x 1/4" phillips head screw
(46)250-303	4	6-32 x 1/4" decorative screw
(47)250-270	4	6-32 x 3/8" black screw
(48)250-89	21	6-32 x 3/8" screw
(49)250-26	13	6-32 x 5/8" screw
(50)250-304	4	6-32 x 3/8" stud
(51)250-227	2	6-32 x 7/8" phillips head screw
(52)250-365	4	#6 x 1/4" sheet metal screw
(53)254-1	38	#6 lockwasher
(54)259-1	4	#6 solder lug
(55)253-1	1	#6 flat fiber washer
(56)253-2	1	#6 shoulder fiber washer
(57)255-13	2	#6 x 1/4" spacer
(58)255-15	2	#6 x 1/2" spacer
(59)255-1	4	Insulator case spacer (thick)
(60)255-74	6	Insulator case spacer (thin)
(61)252-3	29	6-32 nut

INSULATORS-GROMMETS

(37) 75-60	3	Mica insulator
(38) 75-88	3	Transistor insulator case
(39) 481-3	1	Capacitor mounting wafer
(40) 73-45	2	1/2" grommet
(41) 75-71	1	Line cord strain relief, flat

WIRE HARNESS-WIRE-SLEEIVING

134-151	1	Wire harness
344-2	1	Large black wire
344-3	1	Large red wire
344-31	1	Large brown wire
344-50	1	Small black wire

<u>PART No.</u>	<u>PARTS Per Kit</u>	<u>DESCRIPTION</u>	<u>PART No.</u>	<u>PARTS Per Kit</u>	<u>DESCRIPTION</u>
#8 Hardware			MISCELLANEOUS		
(62)250-137	6	8-32 x 3/8" screw	Electrical Components		
(63)254-2	6	#8 lockwasher	54-180	1	Power transformer
(64)252-4	6	8-32 nut	(81) 69-13	1	Relay
Other Hardware			407-120	1	Meter
(65)253-10	4	Control washer	(82) 412-15	2	Neon lamp
(66)254-4	3	Control lockwasher	(83) 413-10	1	Red lens
(67)259-10	1	Control solder lug	413-14	1	Amber lens
(68)252-7	4	Control nut	(84) 421-25	1	1-1/2 ampere slow-blow fuse
(69)252-32	2	Push-on speednut	89-23	1	Line cord
METAL PARTS			432-27	1	Line cord adapter
Chassis-Cabinet Parts			Other Components		
(70)203-476	1	Front panel	(85) 211-33	2	Handle
(71)203-477	1	Rear panel	(86) 462-245	4	Knob
(72)200-484	1	Chassis	(87) 455-50	4	Knob bushing
(73)204-767	2	Siderail	(88) 427-3	3	Binding post base
(74)204-759-1	4	End cap	(89) 75-17	6	Binding post bushing
(75)90-350-2	2	Cabinet half shell	(90) 100-16-2	2	Binding post cap (black)
(76)210-35	1	Bezel	100-16-18	1	Binding post cap (red)
Other Metal Parts			(91) 261-28	4	Stick-on rubber foot
(77)205-545	1	Heat sink plate	(92) 261-30	2	Line cord retainer
(78)204-565	1	Relay mounting bracket	(93) 490-5	1	Nut starter
(79)207-2	1	Capacitor mounting clamp	(94) 352-13	1	Silicone grease
(80)260-24	1	Diode clip	597-260	1	Parts Order Form
			597-308	1	Kit Builders Guide
			391-34	1	Blue and white label
				1	Manual (See front cover for part number.)
					Solder



- () Turn each control and switch shaft to its full counterclockwise position.
- () Press knobs firmly onto the two lower (Fine) control bushings with the pointers at the 7 o'clock position.
- () With the bushings installed on them, remove the two lower knobs. Press the knob bushings firmly into these knobs with the handle of a screwdriver.
- () Reinstall the two lower knobs.
- () Install a knob lightly on each of the two upper controls (Coarse) with the pointer at the full counterclockwise position.
- () Turn each upper knob clockwise to see if the pointer lines up with each switch marking.
- () If the pointers line up properly, press the knobs firmly onto the bushings and then remove the knobs with their bushings. Press the bushings firmly into the knobs with a screwdriver handle, then reinstall the knobs. If a pointer does not line up properly, perform the next three steps.

NOTE: It is not necessary to perform the next three steps if the pointer lines up properly at each switch marking.

1. () Turn the knob pointer to a mid-position marking on the panel.
 2. () Remove the knob from the bushing and turn it slightly to line up the pointer with the mid-position marking.
 3. () Press the knob slightly onto the knob bushing. Then turn the knob to each switch position and recheck the pointer alignment. If more than a slight error is noticed at either end position, repeat these three steps.
- () When the pointer lines up properly with the switch positions, remove the knob and bushing together and press the bushing firmly into the knob with a screwdriver handle. Then replace the knob on the shaft.

This completes the assembly of your Heathkit Regulated Low Voltage Power Supply. Carefully inspect all connections for loose wires or unsoldered joints. Remove any wire clippings or solder splashes that may be lodged in the wiring. Do not install the two R255A transistors until you are instructed to do so. Proceed to the Initial Tests And Adjustments section.

INITIAL TESTS AND ADJUSTMENTS

RESISTANCE TESTS

CAUTION: Be sure to make each of the following tests before you turn on the Power Supply. A wiring error could permanently damage the transistors and diodes.

- () Make sure the transformer leads that go to the rear wafer on the COARSE VOLTAGE switch are connected in the following order: Starting at the lower left side of the switch as you view the switch from the rear, you should find red/green, green/black, red/black, gray, yellow/blue, yellow/red, yellow/green, yellow/black, green, and blue. The blue lead should be followed by the large gray harness wire.

Refer to Figures 1 and 2 (fold-out from Page 43) for location of the controls on the front and rear panels of the Power Supply.

- () Set the front panel controls of the Power Supply as follows:
 - COARSE VOLTAGE: AC OFF.
 - COARSE CURRENT: 1.5 a.
 - FINE VOLTAGE: fully counterclockwise.
 - FINE CURRENT: fully counterclockwise.
 - RESET-STANDBY: down.
 - CURRENT-VOLTAGE: VOLTAGE.
- () Place the rear panel METER switch in NORMAL position.

If the resistance readings you obtain in the initial tests are not within $\pm 20\%$ of the values given in the steps, refer to the In Case Of Difficulty section of this Manual. After the difficulty has been located and repaired, return to this part of the Manual and complete the Resistance Tests.

NOTE: A Power Supply front panel meter indication will be given in each of the next few steps. This meter indication is for VTVM and volt-ohm-milliammeter readings only. If a Heathkit Model IM-25 Solid-State VOM is being used, the Power Supply meter will only show a slight upward deflection for each of these measurements because the Ohms test voltage is very low.

IMPORTANT: Since you will be measuring resistance in semiconductor circuits, you must be sure of the polarity of your ohmmeter test leads. To do this, perform the next four steps.

1. Turn your ohmmeter range switch to its highest resistance range; then connect its test leads to the terminals on the meter in the Power Supply.
2. Change the ohmmeter range switch to successively lower ranges until the Power Supply meter begins to deflect in either direction.
3. If the Power Supply meter deflects up-scale, the lead that is connected to the + meter terminal is the positive ohmmeter lead, and the other is the negative ohmmeter lead. If the meter deflects to the left, the ohmmeter leads are reversed.
4. Disconnect the ohmmeter leads from the Power Supply meter.

() Place the ohmmeter on the RX1000 scale.

() Connect the negative ohmmeter lead to the negative (-) Power Supply binding post, and connect the positive ohmmeter lead to the positive (+) Power Supply binding post. The ohmmeter should indicate $4700\ \Omega$ and the Power Supply meter should deflect upwards to about one-fourth of full scale.

() Turn the COARSE VOLTAGE switch to the .5-5 V position. The resistance should remain around $4700\ \Omega$ and the Power Supply meter should deflect about the same as in the previous step.

() Turn the COARSE VOLTAGE switch to the 5-10 V range. Resistance should increase to $15\ K\Omega$ and the Power Supply meter reading should decrease.

() Turn the COARSE VOLTAGE switch to the 10-15 V position. The resistance indication and the Power Supply meter reading should remain about the same.

() Turn the COARSE VOLTAGE switch to the 15-20 V position. The resistance should increase to $47\ K\Omega$, and the Power Supply meter deflection should decrease.

() Slowly turn the COARSE VOLTAGE switch through each of the remaining positions. The resistance should remain at $47\ K\Omega$ and the Power Supply meter reading should remain about the same.

() Return the COARSE VOLTAGE switch to the AC OFF position.

() Place the RESET-STANDBY switch in the DC ON position. The ohmmeter reading should decrease to around $500\ \Omega$, then slowly increase to over $1100\ \Omega$ as $500\ \mu\text{fd}$ capacitor C9 charges.

() Connect the negative ohmmeter lead to the chassis and touch the positive ohmmeter lead alternately to one of the mounting screws on each of the transistors on the Power Supply rear panel. Readings from all screws to the chassis should show infinite resistance.



- () Touch the positive ohmmeter lead to the positive (+) Power Supply binding post. Resistance should again be infinite.
- () Check the resistance across 3000 μ fd electrolytic capacitor C5. With the ohmmeter leads properly polarized, resistance should be very low at first, and then increase to over 1400 Ω as C5 becomes charged.
- () Connect the negative ohmmeter lead to the negative (-) Power Supply binding post.

NOTE: In the following tests, you will check the resistance at each lug on terminal strip CE. Refer to Pictorial 12 (fold-out from Page 26) to identify the terminal strip lug numbers. All resistance values are in ohms.

The following resistance checks can be made with the ohmmeter in an 11 megohm input VTVM, or the ohmmeter in a 20,000 Ω /volt-ohm-milliammeter. The Heathkit Model IM-25 Solid-State VOM may also be used. You will note that different resistance readings are shown, in some instances, for each type of ohmmeter. These differences are due to the semi-conductors in the Power Supply, which respond with different resistances as they are activated by the different test voltage from each type of ohmmeter.

LUG NUMBER	OHMMETER RANGE	RESISTANCE VALUES, AS MEASURED ON:		
		VTVM	20,000 Ω /Volt VOM	HEATHKIT IM-25
() 1	RX 1	40	35	75
() 2	RX 100	450	425	325
() 3	RX 100	500-1600	500-1200	500-1300
() 4	RX 100	2000	1800	1900
() 5	RX 100	340	350	375
() 6	RX 100	500-1600	500-1200	500-1300
() 7	RX 100	1100	1200	1300

This completes the Resistance Tests. Disconnect the ohmmeter from the Power Supply.

CALIBRATION ADJUSTMENTS

- () Cut each lead of two R265A transistors (#417-20) to a length of $7/32$ " from the transistor body as shown in Detail 13B.

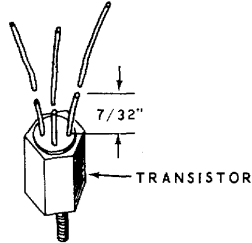

Detail 13B

- () Install the two R265A transistors in the sockets at Q2 and Q3. See Figure 1 (fold-out from Page 43).
- () Set the front panel controls and switches of the Power Supply as follows:
 - COARSE VOLTAGE: AC OFF.
 - COARSE CURRENT: 1.5 a.
 - FINE VOLTAGE: center of rotation.
 - FINE CURRENT: fully clockwise.
 - CURRENT-VOLTAGE: VOLTAGE.
 - RESET-STANDBY: down.
- () Set the controls and switches on the rear panel as follows:
 - ZENER CURRENT - fully counterclockwise.
 - VOLTAGE CALIBRATE - center of rotation.
 - METER - ZENER CURRENT position.
 - DC REGULATION - $1/8$ turn from full clockwise position.
- () Adjust the meter pointer to zero, if necessary, with a small screwdriver.
- () Plug the line cord into a standard AC outlet. Turn the COARSE VOLTAGE switch to the .5-5 volt position.

NOTE: When the METER switch is in its present ZENER CURRENT position, the front panel meter will indicate 5 milliamperes of current at its full scale position.

- () Adjust the ZENER CURRENT control for a reading of approximately 4 milliamperes on the meter. This setting is not critical because there may be some warm-up drift.
 - () Press the rear panel METER switch to NORMAL and the RESET-STANDBY switch to DC ON.
 - () Turn the FINE VOLTAGE control back and forth and watch the meter. The voltage reading should swing from almost zero to more than full scale. If operation appears normal, continue with the following steps. If there appears to be any difficulty, refer to the In Case Of Difficulty section of the Manual.
 - () Set the FINE VOLTAGE control at the full clockwise position.
 - () Place the COARSE VOLTAGE switch in the 45-50 V position. Then adjust the VOLTAGE CALIBRATE control for a full scale reading on the meter.
 - () Place the rear panel METER switch in the ZENER CURRENT position.
 - () Adjust the ZENER CURRENT control for a current of 5 milliamperes, as indicated on the meter.
- NOTE: The setting of the ZENER CURRENT control is not critical. The current may vary, depending on line voltage, warm up, and loads on the Power Supply.
- () Return the rear panel METER switch to the NORMAL position. If necessary, readjust the VOLTAGE CALIBRATE control for a full scale reading. Repeat this step and previous two steps until each position of the meter switch gives the correct indication. Leave the METER switch in NORMAL position.
 - () Return the COARSE VOLTAGE switch to the AC OFF position.

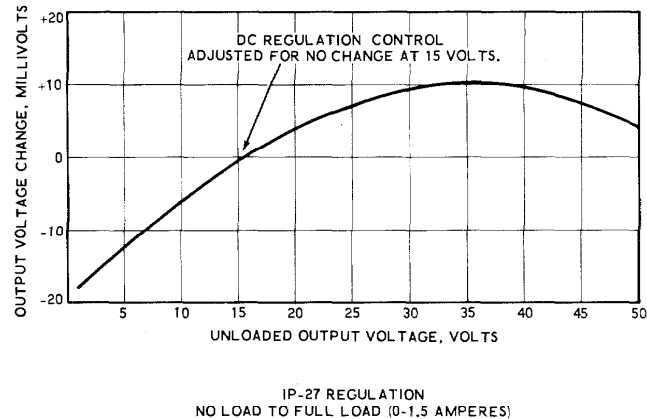

Figure 3

DC REGULATION CONTROL ADJUSTMENT

The following method of setting the DC REGULATION control will provide a degree of stability that is adequate for all but the most exacting requirements. When adjusted by this method, the Power Supply's regulation characteristics are as shown in Figure 3. If greater accuracy is desired, you can obtain it by using a differential voltmeter, instead of the front panel meter, to measure the output voltage in the following steps.

- () Locate a load that will withstand 1.5 amperes at 15 volts. This load value is equal to a 10 Ω resistor rated at 22-1/2 watts or greater. If such a resistor is not available, an ordinary electric flatiron will present a load that is sufficiently correct for this purpose (10 to 15 Ω).

- () Connect the load between the negative (-) and positive (+) terminals of the Power Supply.

- () Set the front panel controls of the Power Supply as follows:

COARSE VOLTAGE: 10-15.
 COARSE CURRENT: 1.5 a.
 FINE CURRENT: maximum clockwise.
 CURRENT-VOLTAGE: VOLTAGE.

- () Adjust the DC REGULATION control on the rear panel until there is no difference in the meter reading between loaded and unloaded conditions. This is the point of optimum regulation.

This completes the Calibration procedure.

FINAL ASSEMBLY

Refer to Pictorial 14 for the following steps.

- () Thread four 6-32 x 3/8" studs into the unused holes in the siderails. Tighten the studs fully.
- () Remove the tape from a plastic handle. Then install the handle on one siderail with the grain side out. Use two 6-32 x 1/4" decorative screws and two end caps, as shown in the Pictorial. Tighten the decorative screws with a penny.
- () In a like manner, install the other handle and end caps on the opposite side of the case.
- () Install four rubber feet on a cabinet half shell as shown in the Pictorial. Remove the paper backing from the feet just before mounting them on the half shell.
- () Position the cabinet half shell, with the sloping edge toward the front, on the bottom of the Power Supply. Fasten it with four 6-32 x 1/4" phillips head screws.

() In a like manner, install the top cabinet half shell as shown on the Pictorial.

() Carefully peel away the paper backing from the blue and white identification label. Then press the label firmly into place on the rear panel.

NOTE: The blue and white identification label that is installed in the next step shows the Model number and Production Series number of your kit. Refer to these numbers in any communications with the Heath Company; this assures you that you will receive the most complete and up-to-date information in return.

This completes the Final Assembly of your Regulated Power Supply.

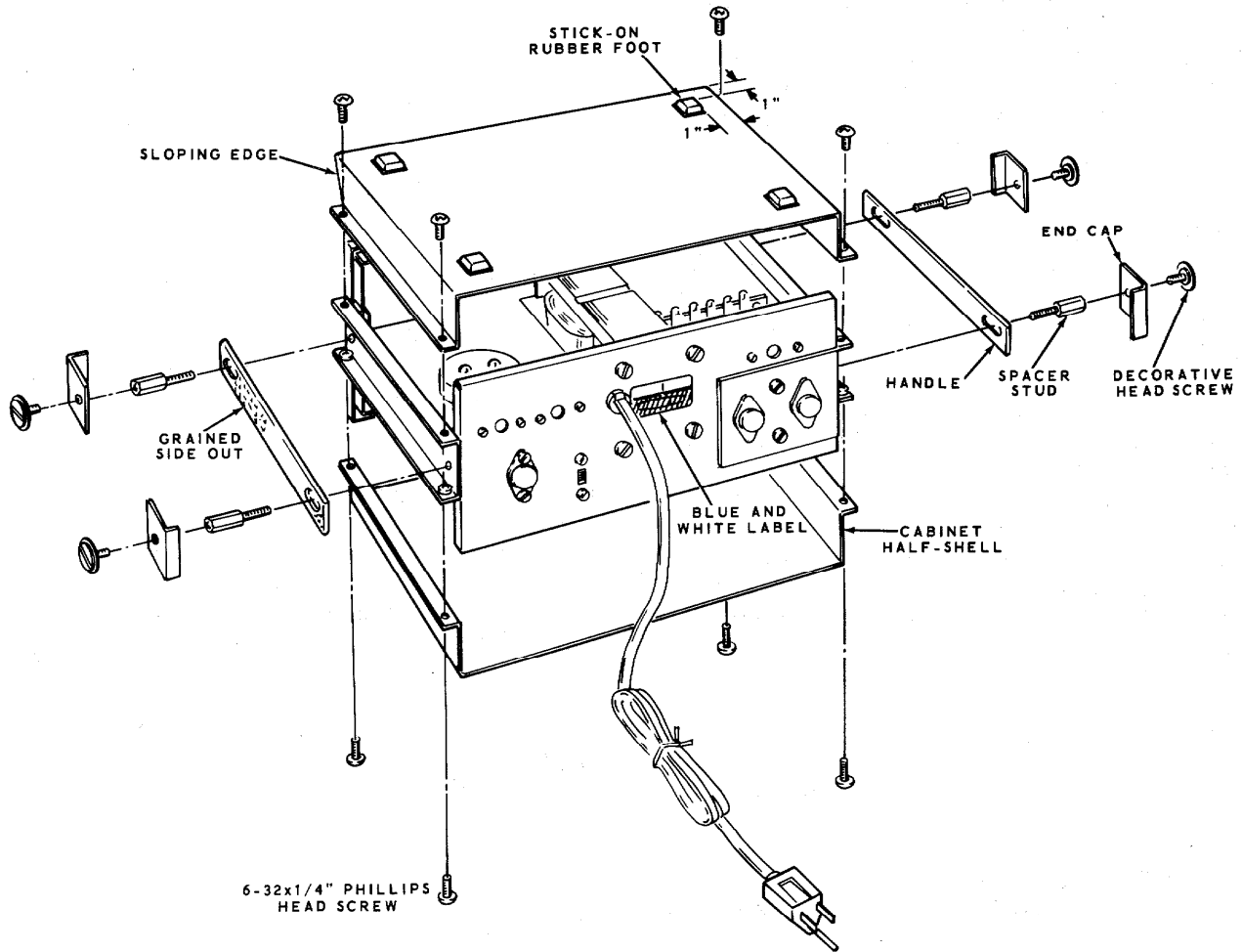

PICTORIAL 14

OPERATION

Before you attempt to use your Regulated Low Voltage Supply, be sure to become familiar with its operating characteristics and features. This will help you put the Power Supply to its fullest use. It would also be helpful to read the Circuit Description.

READING THE METER

The front panel meter has a 0-15 scale printed in black, and a 0-50 scale printed in red. The COARSE CURRENT and COARSE VOLTAGE switches have some ranges printed in black and others in red. Voltage or current is read on the meter scale that matches the switch position color.

All voltage ranges except the .5-5 are read directly on the appropriate meter scale. The .5-5 volt range reads on the red 0-50 scale, with the zero dropped. Thus, a reading of 40 would indicate 4.0 volts.

The 50 ma current range is read directly on the red 0-50 scale. The 150 ma and 500 ma current ranges are read on the 15 and 50 scales, respectively, by placing a zero after the meter reading. To read the 1.5 ampere range, use the 15 scale and move the decimal one place to the left. For example, a reading of 10 on the black scale, in the 1.5 ampere range, would indicate 1.0 amperes.

NORMAL OPERATION

1. Position the front panel controls and switches as follows:

COARSE VOLTAGE: AC OFF.

COARSE CURRENT: 1.5 a (or slightly higher than the expected load).

FINE VOLTAGE: full counterclockwise.

FINE CURRENT: full clockwise.

CURRENT-VOLTAGE: VOLTAGE.

RESET-STANDBY: DC ON.

2. Adjust the COARSE VOLTAGE and the FINE VOLTAGE for the exact voltage you desire, as indicated on the meter.
3. Place the RESET-STANDBY in the RESET-STANDBY position.
4. Connect the load to the positive (+) and negative (-) binding posts.
5. Place the RESET-STANDBY switch in the DC ON position.
6. Press the CURRENT-VOLTAGE switch to the CURRENT position.
7. Turn the FINE CURRENT control counterclockwise until the current begins to decrease. Then turn the control clockwise to just beyond the point where current begins to decrease. This is the correct operating point for the load.

Be sure to follow each voltage adjustment with a current adjustment, as in the previous step. If you do not and the current limit is set too low, your circuit will not operate properly due to a lack of sufficient current. If the current limit is set too high, current overloads could damage your circuits.

It would be wise to frequently scan the Power Supply meter during operation for any changes in load characteristics.

PARALLEL OPERATION

For higher current loads, two or more Power Supplies can be connected in parallel as shown in Figure 4. Parallel connection is accomplished as described in the following steps.

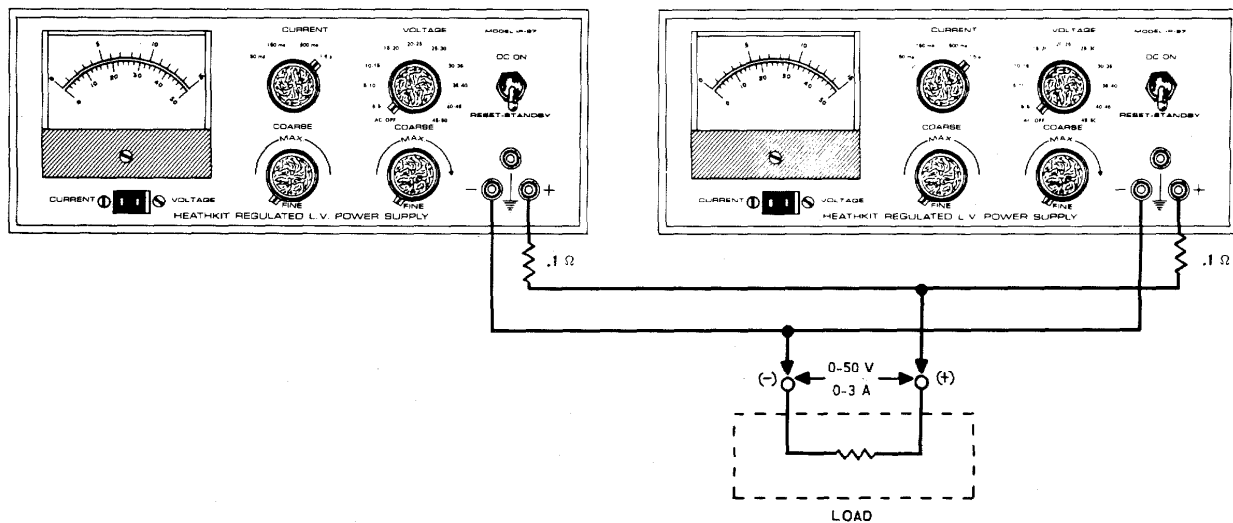

Figure 4

1. Set the COARSE VOLTAGE and CURRENT switches to identical ranges on each Power Supply. The range should match the current and voltage to be supplied.
2. Place a $.1 \Omega$ resistor in series with the positive (+) lead of each Power Supply as shown. Do not connect the load at this time.
3. Connect together the negative (-) binding posts of all Power Supplies.
4. Touch the positive (+) lead of one Power Supply to the positive lead of another Power Supply and note whether a voltage change occurs on either meter. Then, if necessary, adjust the FINE VOLTAGE control on one of the Supplies until there is no change in the voltage indication, on either meter, between the connected and disconnected condition of the positive leads.
5. If there are more than two Power Supplies being connected in parallel, repeat the previous step until all Power Supplies have been adjusted for no change in the connected and disconnected voltage indication.
6. Adjust the current controls on each Power Supply so as to split the load evenly between each supply, once the known load requirements have been established.
7. Connect the load as shown in Figure 4.

This is the proper operating condition for Power Supplies in parallel. Remember that each time you change the voltage setting of one of the Power Supplies, you must also change the others by an equal amount or one Power Supply may load the others.

SERIES OPERATION

Two or more Power Supplies can be connected in series for voltages greater than 50 volts. The correct method of connecting Power Supplies for series operation is shown in Figure 5. Current control settings should be identical in each series unit, but voltage control settings can be distributed between the Power Supplies as desired. The following precautions should be observed when connecting Power Supplies for series operation:

1. Be sure to have a common ground connection between each Power Supply and the unit being supplied with power. This common ground occurs automatically if all units use 3-wire line cords. If all units do not use 3-wire line cords, connect the ground (\perp) binding post of each Power Supply to the chassis of the unit being supplied with power.

2. Use the RESET-STANDBY switch in both Power Supplies to turn on or to interrupt the output voltage and current.

NOTE: The "hot" end of a series string of Power Supplies can be at either the most positive or the most negative point, depending on which Power Supply lug is connected to the chassis.

AMMETER CORRECTION FACTOR

There is a 2 ma offset in current meter readings. While this is a relatively small error on the higher current ranges, it is worth considering when reading currents of less than 150 ma. The actual current supplied is 2 ma less than that read on the meter.

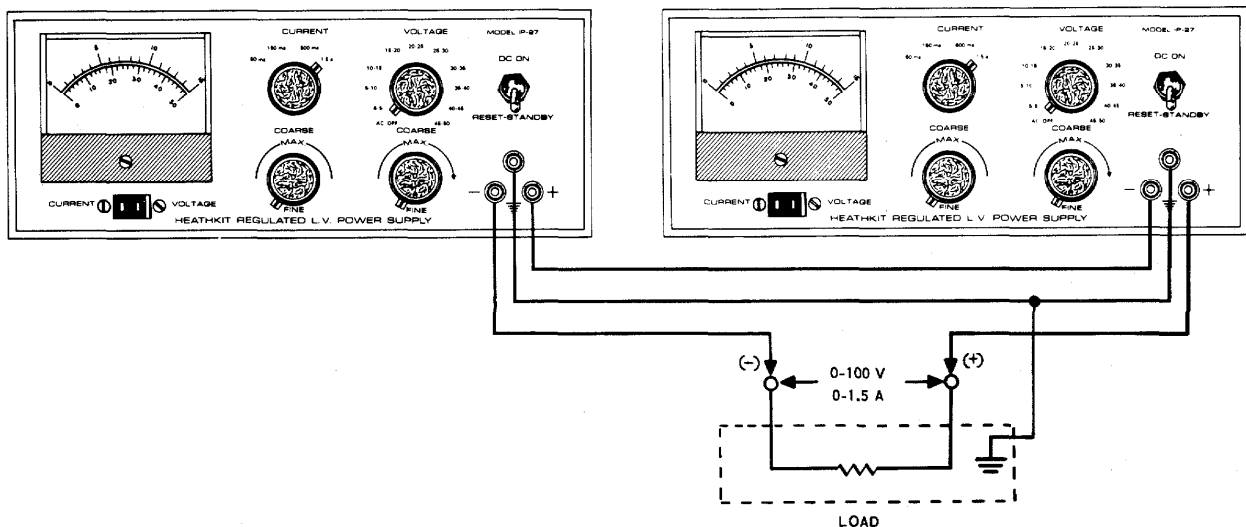

Figure 5

CURRENT LIMITER USE

The Power Supply will furnish a maximum current of 1.5 amperes. This means that you should not attempt to operate a load that requires 1.5 amperes under "no signal" conditions, as the current limiter circuit in the Power Supply would automatically cut the Power Supply off as the load began drawing more than 1.5 amperes under signal conditions. For example, assume that a transistorized audio amplifier requires 1.0 amperes under no-signal conditions. If a sine wave is applied to the amplifier, the current demand on the Power Supply will also vary in a sine wave fashion. With a 1.0 ampere no-signal level, the current drain can vary .5 ampere without limiting in the Power Supply. However, should the signal vary the current demand more than .5 ampere, the Power Supply will clip. This condition can be minimized by connecting a very large capacitor (1000 μ fd or more) across the output of the Power Supply. The capacitor will discharge into the load during the limiting period and, therefore, reduce the clipping action.

CAUTION: When using the large capacitor, the capacitor must be completely discharged before it is connected across the output of the Power Supply. Always start the Power Supply with the COARSE VOLTAGE switch at the lowest range and slowly increase the voltage to the desired level. This will prevent any high current surge that may cause the overload relay in the Power Supply to open.

OVERLOAD RELAY

The overload relay keeps low resistance and short circuited loads from damaging the Power Supply. This relay automatically opens up the DC current path (ahead of the current limiter stage) in the Power Supply when the current limiter transistor is overloaded.

The overload relay may not always operate, and its action is not needed, below 10 volt output levels. Any overloads that begin to occur at these low levels can be handled by the current limiter circuit.

DC REGULATION CONTROL

On rare occasions, at some specific voltage, it may be desirable to have a voltage regulation that will produce less than the specified ± 15 millivolts change in output voltage from no load to full load. In this event, simply adjust the DC REGULATION control at the desired voltage for identical readings at the no load and full load conditions. This setting of the control will sacrifice regulation at other voltages, so be sure to return the control to its original setting after this application is completed.

IN CASE OF DIFFICULTY

1. Recheck the wiring. Trace each lead in colored pencil on the Pictorial as it is checked. It is frequently helpful to have a friend check your work. Someone who is not familiar with the unit may notice something consistently overlooked by the builder.
2. About 90% of the kits that are returned for repair, do not function properly due to poor connections and soldering. Therefore, many troubles can be eliminated by reheating all connections to make sure that they are soldered as described in the Soldering section of the Kit Builders Guide.
3. Check the values of the parts. Be sure that the proper parts have been wired into each circuit, as shown in the Pictorial diagrams and as called out in the wiring instructions.
4. Check for bits of solder, wire ends or other foreign matter which may be lodged in the wiring.
5. If, after careful checks, the trouble is still not located and a voltmeter is available, check voltage readings against those shown on the Schematic Diagram. NOTE: All voltage readings were taken with an 11 megohm input vacuum tube voltmeter. Voltages may vary as much as $\pm 10\%$.
6. A review of the Circuit Description may help you locate the trouble.

NOTE: In an extreme case where you are unable to resolve a difficulty, refer to the Service and Warranty section of the "Kit Builders Guide", and to the "Factory Repair Service" information below.

FACTORY REPAIR SERVICE

You can return your completed kit to the Heath Company Service Department to have it repaired for a minimum service fee. (Kits that have been modified will not be accepted for repair.) If you wish, you can deliver your kit to a nearby Heath Authorized Service Center. These centers are listed in your Heathkit catalog.

To be eligible for replacement parts under the terms of the warranty, equipment returned for factory repair service, or delivered to a Heath Authorized Service Center, must be accompanied by the invoice or the sales slip, or a copy of either. If you send the original invoice or sales slip, it will be returned to you.

If it is not convenient to deliver your kit to a Heath Authorized Service Center, please ship it to the factory at Benton Harbor, Michigan and follow the following shipping instructions:

Prepare a letter in duplicate, containing the following information:

- Your name and return address.
- Date of purchase.
- A brief description of the difficulty.
- The invoice or sales slip, or a copy of either.
- Your authorization to ship the repaired unit back to you C.O.D. for the service and shipping charges, plus the cost of parts not covered by the warranty.

Attach the envelope containing one copy of this letter directly to the unit before packaging, so that we do not overlook this important information. Send the second copy of the letter by separate mail to Heath Company, Attention: Service Department, Benton Harbor, Michigan.

Check the equipment to see that all parts and screws are in place. (Do not include wooden cabinets when shipping receivers, tuners, amplifiers, or TV sets, as these are easily damaged in shipment.) Then, wrap the equipment in heavy paper. Place the equipment in a strong carton, and put at least THREE INCHES of resilient packing material (shredded paper, excelsior, etc.) on all sides, between the equipment and the carton. Seal the carton with gummed paper tape, and tie it with a strong cord. Ship it by prepaid express, United Parcel Service, or insured parcel post to:

Heath Company
Service Department
Benton Harbor, Michigan 49022

TROUBLESHOOTING CHART

TROUBLE	POSSIBLE CAUSE
Neither pilot lamp will light.	<ol style="list-style-type: none"> 1. Blown fuse. 2. AC Power switch.
High output voltage, or no response from FINE VOLTAGE control.	<ol style="list-style-type: none"> 1. Faulty transistor Q2 or Q3. 2. Zener diode Z1. 3. Zener diode Z2.
Normal output voltage with no load, dropping to a low value or zero with load.	<ol style="list-style-type: none"> 1. Faulty transistor Q3.
Low output voltage, or no response from FINE VOLTAGE control.	<ol style="list-style-type: none"> 1. Zener diode Z1. 2. Zener diode Z2. 3. Transistor Q2. 4. Diodes D1, D2, D3, D4, D5, or D6. 5. Bias supply for transistor Q1.
No output voltage.	<ol style="list-style-type: none"> 1. Transistors Q1, Q2, Q4, or Q5.
High zener current or low zener current.	<ol style="list-style-type: none"> 1. Zener diode Z1. 2. Zener diode Z2. 3. High or low line voltage. 4. Resistors R1, R2.
Loss of current limiting.	<ol style="list-style-type: none"> 1. Transistor Q1. 2. Diode D7.
Relay pulls in on any load at over 6 volts.	<ol style="list-style-type: none"> 1. Transistor Q2.
Relay chatters or clicks on and off.	<ol style="list-style-type: none"> 1. Transistor Q4 or Q5. 2. Transistor Q2.
Relay will not operate.	<ol style="list-style-type: none"> 1. Diode D8. 2. Relay coil open.
Power supply oscillates.	<ol style="list-style-type: none"> 1. Capacitor C9.
Resistor R12 (.82 Ω) burns.	<ol style="list-style-type: none"> 1. Transistors Q1, Q4, or Q5 shorted to chassis through mica insulator. 2. Short circuit at output binding posts. 3. Capacitor C9.
Poor or no regulation.	<ol style="list-style-type: none"> 1. Diode D7. 2. Transistor Q2. 3. Transistor Q3. 4. Transistors Q1, Q4, or Q5 shorted to chassis through mica insulator.



SPECIFICATIONS

Load Regulation.	Output variation less than ± 15 millivolts from no load to full load, for output of .5 to 50 volts DC. Can be adjusted for no variation at a given voltage.
Line Regulation.	Less than .05% change in output voltage with a 5% change in line voltage.
Ripple and Noise.	250 microvolts maximum,
Transient Response.	Less than 25 microseconds at 1 kHz.
Output Impedance.	Less than .075 Ω from DC to 10 kHz. Less than .3 Ω above 10 kHz.
Meter Size.	3-1/2".
Meter Current Ranges.	50 ma, 150 ma, 500 ma, 1.5 a.
Meter Voltage Ranges.	15 and 50 volts.
Power Requirements.	105-125 volts, or 210-250 volts, 50/60 Hz, 135 watts at full load (50 V at 1.5 a).
Dimensions.	5-1/8" high x 13-1/4" wide x 9" deep.
Net Weight.	12 lbs.

The Heath Company reserves the right to discontinue instruments and to change specifications at any time without incurring any obligation to incorporate new features in instruments previously sold.

THEORY OF OPERATION

Qualifications for a perfect power supply would include zero internal resistance, a feature that is theoretically ideal but not practically possible. When a load is connected to the output terminals, the voltage tends to decrease due to the increased current flow through the internal resistance. A common example of this loss due to the internal resistance of a power supply can be seen when

the lights on a car dim as the engine is being started. The automobile storage battery, which is the power supply in this case, contains enough internal resistance to present reduced voltage to the car during the heavy current drainage from the starter motor. This reduced voltage causes the lights to dim.

A regulated Power Supply is designed to simulate an ideal zero internal resistance condition. This is done by using automatic correction (regulating) circuits to hold the output voltage at a constant level.

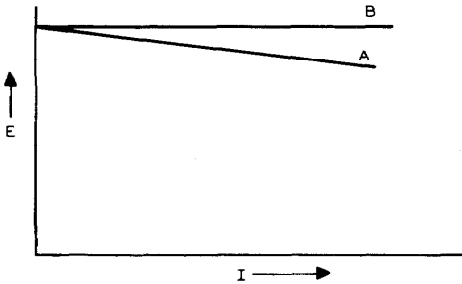

Figure 6

In Figure 6, line A represents the output of a typical power supply. As the current (I) increases, the voltage (E) decreases. Line B represents a regulated Power Supply where the voltage remains constant with increasing current. Figure 7 shows a basic voltage regulated power supply, where E_S is a DC voltage source, and R_I is the internal resistance of the voltage source. E_{REF} is an independent reference voltage source of the same voltage as desired from the output. When a load, R_L , is applied to the output terminals, current flows. This current flow causes a voltage drop across R_I and R_R , with an attendant voltage drop between the (+) and (-) output terminals.

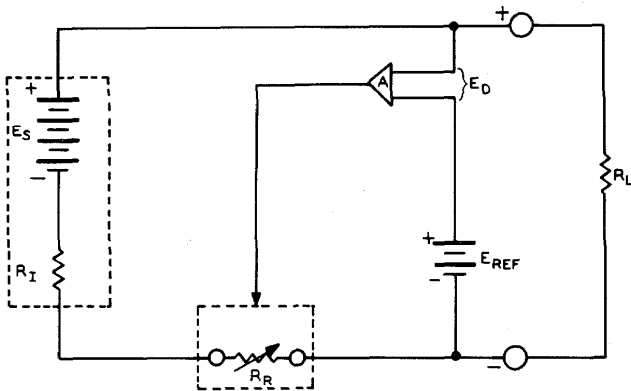

Figure 7

At the same time, the difference voltage, E_D , occurs at the input of amplifier A. This difference is amplified in A to produce a usable error signal. The error signal is then transferred to some form of variable resistance, such as a transistor (R_R), in series with the load path.

Now, when the output voltage starts to decrease, the error voltage causes resistance R_R to decrease also. This causes less voltage to be dropped across R_R and compensates for the voltage drop across R_I . Thus, when the voltage drop across R_I increases, the voltage across R_R decreases by an equal amount and the output voltage is held at the same level.

Although the foregoing is a simplified description of the regulating action, the important point to remember is that a feedback system of the correct value and speed can be made to perform the regulating function. It can also be seen that the original supply voltage must be considerably higher than the desired output voltage, in order to compensate for the voltage drop in series resistance R_R and internal resistance R_I .

It is desirable to limit the current that can be drawn from a regulated power supply in order to protect both the load and the supply. The current curve for such a condition is shown in Figure 8, where the voltage remains constant for all currents up to a predetermined value and then drops, while the current remains nearly constant.

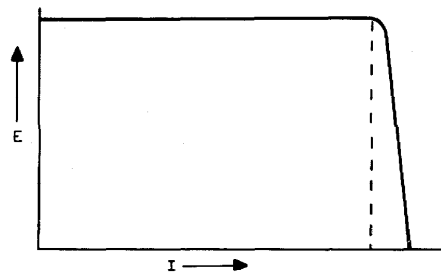

Figure 8

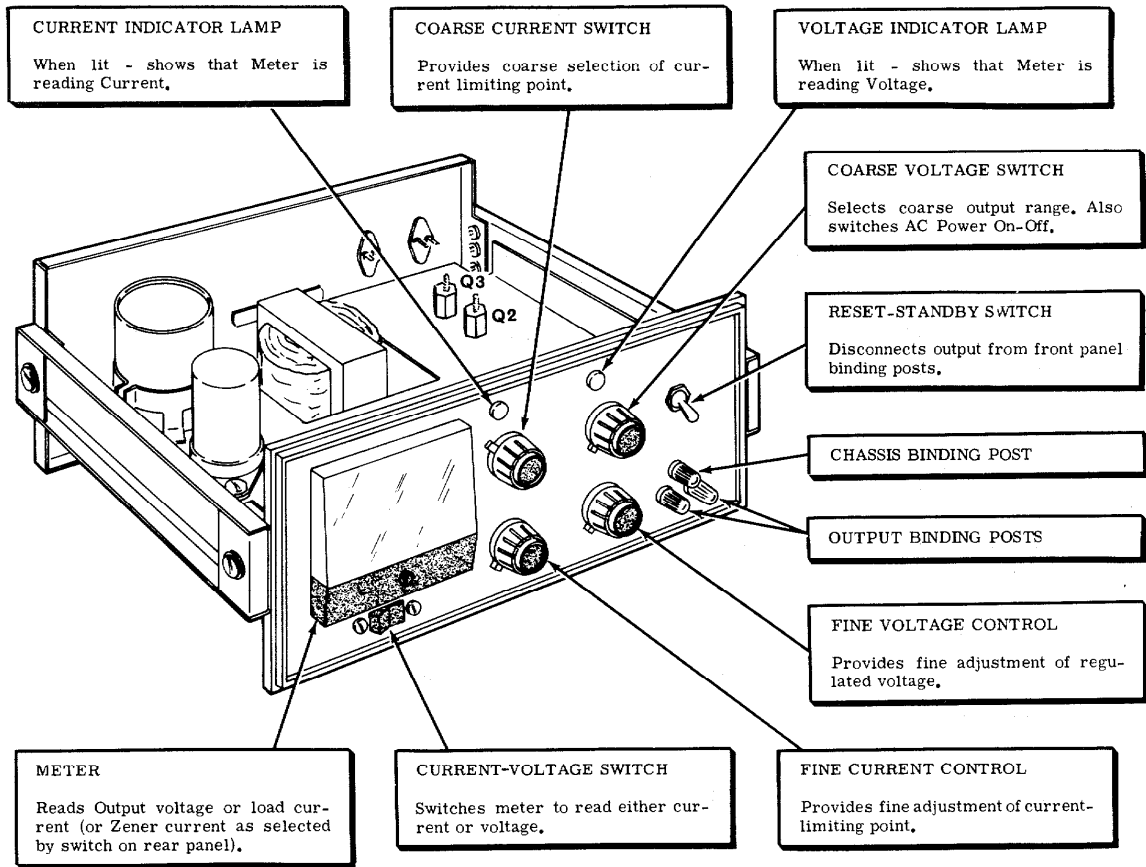

FIGURE 1

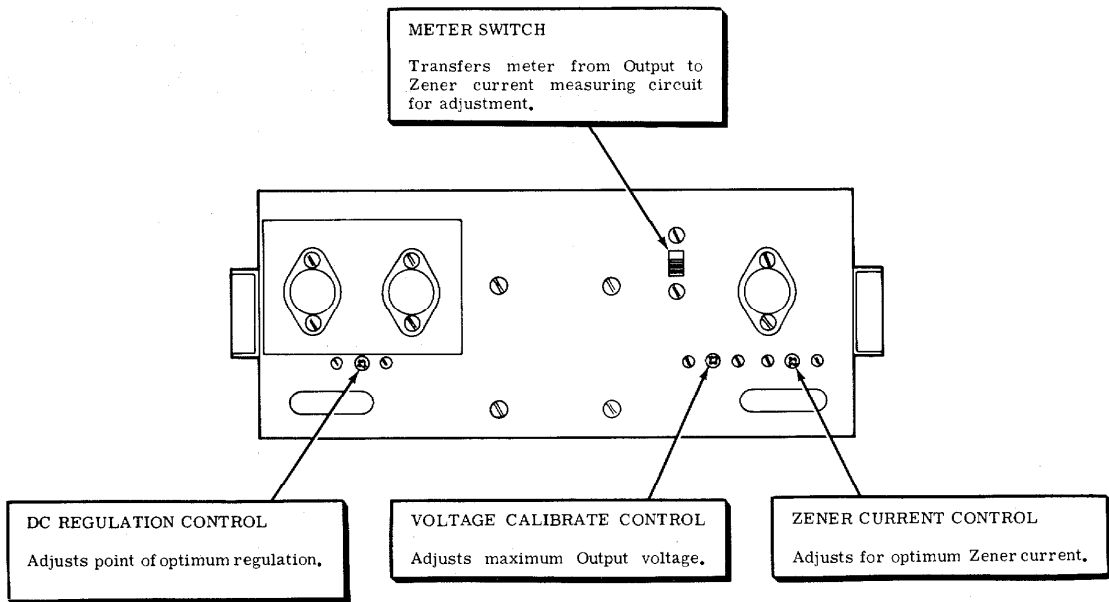

FIGURE 2

CIRCUIT DESCRIPTION

The Regulated Low Voltage Power Supply consists of the following five major circuits:

1. Power source
2. Current limiter
3. Voltage regulator
4. Reference voltage source
5. Metering circuits

Each of these circuits will be described separately. Refer to the Block Diagram (fold-out from this Page), and to the Schematic Diagram (fold-out from Page 51), while you read this Circuit Description.

POWER SOURCE

The primary windings of the power transformer may be connected in parallel for operation from a 105 to 125 volt or in series for operation from a 210 to 250 volt 50/60 Hz AC source.

A multi-tap secondary winding on the transformer supplies the voltage and current that later becomes the regulated output. The taps are selected by one section of the Coarse Voltage switch (CV-4FR). The voltage at any given tap is higher than the output voltage for that switch position, since there is some power dissipation in the regulator circuits.

Power dissipation is minimized by controlling the source voltage with the 10-step Coarse Voltage switch. Thus, the regulator circuits need only operate over a small range in any switch position.

The selected transformer voltage is changed to DC in a full-wave rectifier circuit that consists of diodes D3 through D6. Capacitor C5 filters the DC voltage, while bleeder resistor R6 provides a constant load to rapidly drop the voltage when the Coarse Voltage switch is changed to a lower range.

CURRENT LIMITING

The current limiting circuit uses a familiar transistor characteristic: the resistance (and the current flow) between the emitter and collector of the transistor can be controlled by its

base voltage. The emitter to collector resistance remains very low up to a certain point, and then increases very rapidly as the base voltage decreases.

Figure 9 is a simplified schematic of the current limiting circuit. In this diagram, the Coarse Current switch and resistors R7, R8, R10, R11, and R12, are represented by Rcc. The limiter bias supply that consists of a 7-volt winding on transformer T1, diode D2, filter capacitor C4, and Resistor R4, provides a bias voltage to the base of transistor Q1 for normal operation.

LIMITER BIAS
POWER SUPPLY

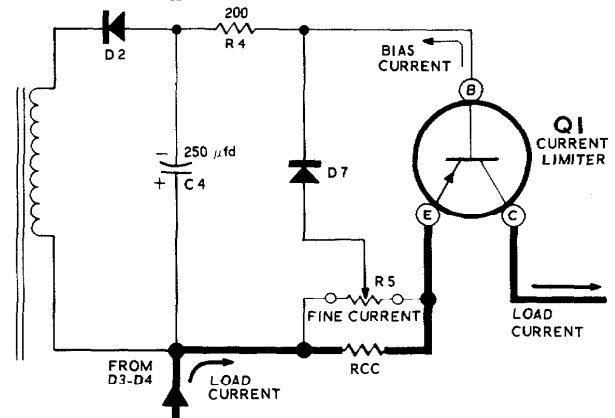
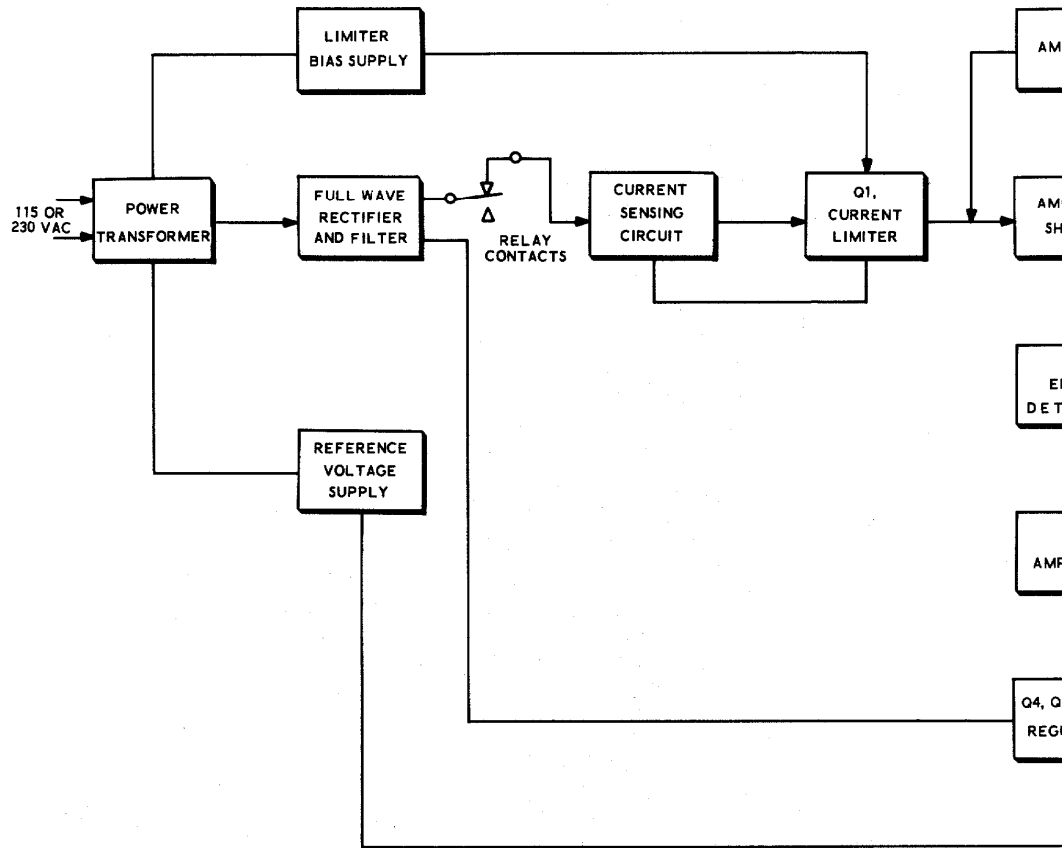

Figure 9

During normal operating conditions, the voltage drop from emitter to collector of Q1 is very small while across the base to emitter the drop is .2 volt. Diode D7 will not conduct unless .6 volt appears across it.

If the current drain from the main voltage source rises sufficiently to cause a drop of .4 volt across Rcc, this voltage adds to the .2 volt from emitter to base in Q1. Now, with the total of .6 volt across diode D7, it begins to conduct and reduces the base voltage of Q1 sufficiently to cause its emitter to collector resistance to rise sharply. This increase in the resistance (and the voltage drop) across the emitter to collector of Q1 reduces the current flow, and current limiting occurs.

The Coarse Current switch is used to select the proper resistance for Rcc to set one of four current ranges, while Fine Current control R5 is



BLOCK DIAGRAM

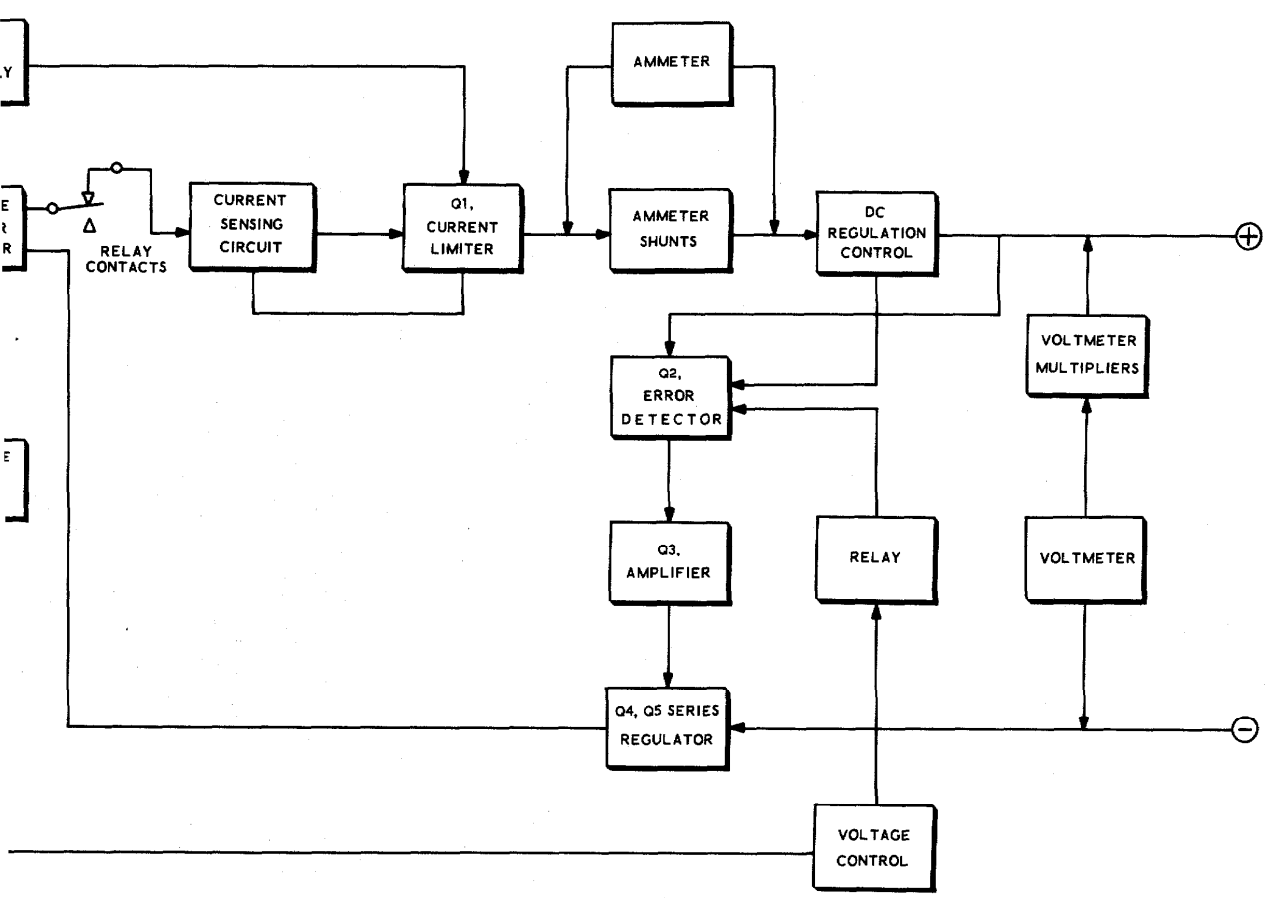

BLOCK DIAGRAM

used to adjust the current within the range selected by the switch. Note that R_{cc} is shown in parallel with the Fine Current control in Figure 9 to simplify the description. The schematic shows this to be a parallel circuit for some ranges, and series for others.

The current limiting circuit and transistor Q1 will handle overloads that are small or at low voltage settings. However, the heat caused by severe overloads could quickly destroy Q1, therefore a protective relay is used. The coil of this relay is connected between the reference voltage power supply and the output terminal. If the output voltage drops, due to the limiting action of transistor Q1, diode D8 conducts current from the reference voltage power supply through the relay coil. When sufficient current flows to produce about 4 volts across the coil, the relay contacts open the source voltage circuit ahead of the current limiter.

When the overload is removed, or the DC switch is changed to the Reset-Standby position, capacitor C8 charges to operating voltage from the reference voltage power supply. Without a sufficient voltage drop across the relay coil, its contacts return to normal and reconnect the main voltage supply to the output terminals.

VOLTAGE REGULATOR

In the voltage regulator circuit shown in Figure 10, the voltage from the main power supply is compared with a constant reference voltage in an error detector transistor. Any difference between the supply and reference voltage is amplified by transistor Q3, which controls a pair of series regulator transistors to restore the correct voltage output.

Error detector transistor Q2 has its emitter connected to the main supply voltage, and its base connected to a constant reference voltage. If the main supply voltage decreases, the collector current in Q2 also decreases. This causes a proportionate voltage decrease at the base and emitter of Q3, and at the bases of series regulator transistors Q4 and Q5. With the decreased base voltage on these transistors, the effective resistance (and the voltage drop) between their emitters and collectors decreases to restore the output voltage to nearly its original value.

An increase in the main supply voltage would cause the opposite action to occur to reduce the output voltage to nearly its original value. In either case, the regulator action takes place in a matter of microseconds.

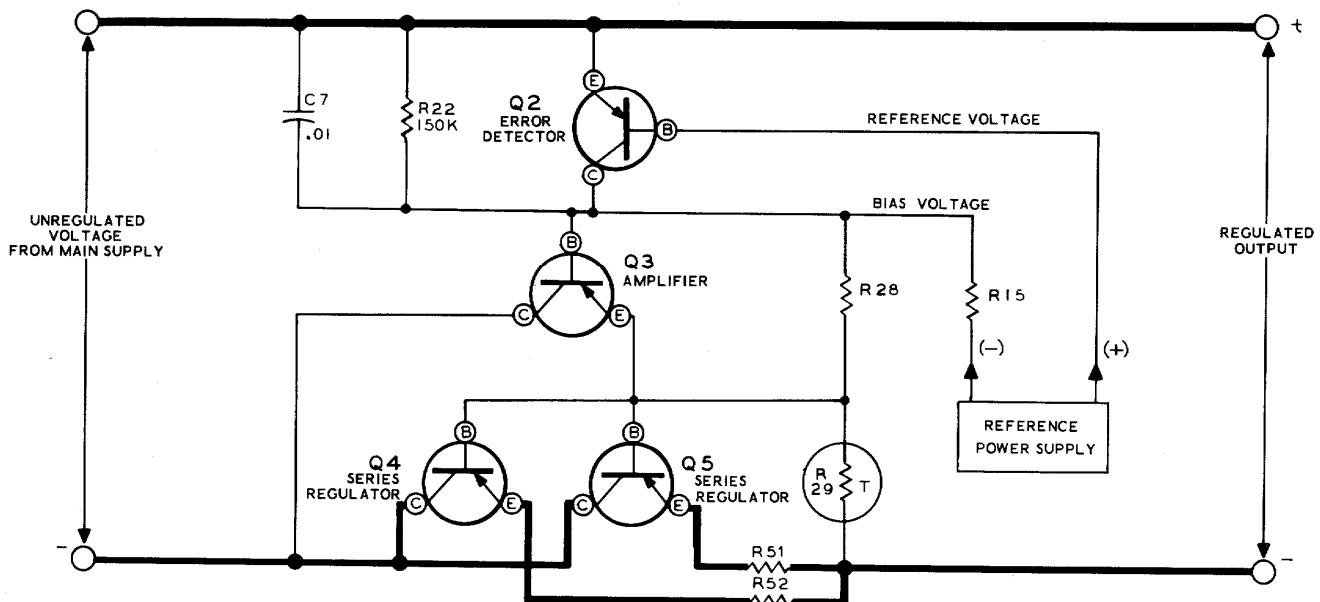

Figure 10

An increase in current drain could still cause a decrease in the voltage output because of the internal resistance of the regulator circuit. Therefore, positive feedback (regeneration) is used to further reduce the effective internal resistance to zero under this condition.

The circuit shown in Figure 11 provides positive feedback around error detector transistor Q2 in the following manner: An increase in load current causes a greater voltage difference across resistor R24 and DC Regulation control R23. A portion of this voltage difference is coupled through R25 to the base of Q2 which in turn decreases the internal resistance of the Power Supply by reducing the series resistance of regulator transistors Q4 and Q5. The DC Regulation control is adjusted to provide a balanced output voltage under full current load and minimum current load conditions.

Resistor R28 and thermistor R29 supply the proper bias to transistors Q4 and Q5. The thermistor is physically located to sense any temperature changes in Q5, and automatically adjusts the bias to compensate for these changes. Resistor R51 and R52 help to equalize the emitter currents in Q4 and Q5.

Resistor R22 and capacitor C7 form a suppressor network to control the speed at which the error detector reacts to a change in terminal voltage. This prevents the regulator circuit from over-responding to sudden momentary changes in the output voltage. Capacitor C9 provides further stability to the regulator circuits and reduces the AC impedance of the output. Capacitor C10 filters any high frequencies at the output terminals.

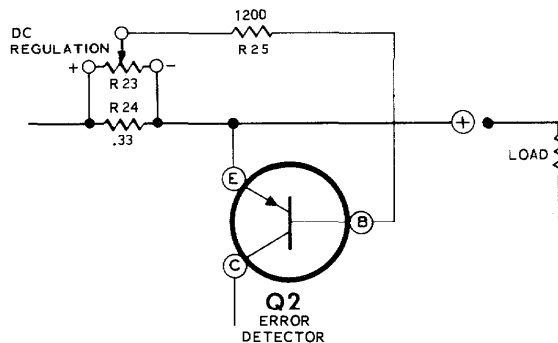

Figure 11

REFERENCE VOLTAGE POWER SUPPLY

A DC reference of 50 volts is produced by the reference voltage power supply. Voltage regulation in this supply is obtained from zener diodes Z1, Z2, and Z3. The regulated DC voltage from the reference supply is used primarily to furnish error detector transistor Q2 with a reference voltage. This standard voltage is used to sense incorrect output from the power supply and regulate the voltage drop across transistors Q4 and Q5.

The AC voltage from the reference voltage winding of the power transformer is rectified by diode D1 and filtered by capacitor C1 and resistor R1. The DC voltage is first regulated at 110 volts by zener diode Z1, than at 68 volts by zener diode Z3, and given additional filtering by resistor R2, capacitors C2 and C3.

The stabilized voltage is applied to zener diode Z2 through resistors R9 and R13, and Zener Current Adjust control R3, which are in series with the diode. The current in Z2 is adjusted to around 5 ma, the diodes optimum operating point. R13 is a meter shunt for measuring zener current.

The regulated voltage across diode Z2 and resistor R13 is then applied to Voltage Calibrate control R14. Control R14 is adjusted so exactly 50 volts is applied across wafer CV-3R of the Coarse Voltage switch, Fine Voltage control R31, and wafer CV-2F of the Coarse Voltage switch, which is connected to the negative (-) output terminal. These two switch sections select any 6 volt portion of the 50 volts and apply it across the Fine Voltage control. The desired reference voltage is then coupled from the arm of this control, through the relay coil, to the base of error detector transistor Q2, where the output voltage of the Power Supply is regulated to essentially the same voltage level.

METER CIRCUIT

The meter is used to monitor either the output voltage, the output current, or the zener diode (Z2) current. Two switches, the Meter switch on the rear panel and the Current-Voltage switch on the front panel, determine which function the meter will measure. The meter is first controlled by the rear panel Meter switch, which has two positions. In the Normal position, the meter is connected to the Current-Voltage switch. In

the Zener Current position, the meter with resistor R32 in series with it, is connected in parallel with resistor R13 to measure the current of zener diode Z2.

The Current-Voltage switch in the Current position, connects the meter across wafer CC-1 of the Coarse Current switch. This wafer selects the proper milliammeter shunt resistors (R16 through R21) for each of the four current ranges: 50 ma, 150 ma, 500 ma, and 1.5 a.

In the Voltage position of the Current-Voltage switch, sections CV-1F and CV-1R of the Coarse Voltage switch select the proper calibrating resistors for each voltage range. The proper resistors are then connected in series with the meter between the negative (-) and the positive (+) output terminals.

A separate section of the Current-Voltage switch applies 120 VAC across either the current or voltage front panel indicator lamp. This section of the switch has shorting type (make before break) contacts so that at least one lamp is on whenever the Power Supply is on.

REPLACEMENT PARTS PRICE LIST

To order parts, use the Parts Order Form furnished with this kit. If Parts Order Form is not available, refer to Replacement Parts in the Kit Builders Guide.

PART No.	PRICE Each	DESCRIPTION
-------------	---------------	-------------

RESISTORS

1/2 Watt 10%

1-41	.10	10 Ω
1-13	.10	2700 Ω
1-16	.10	4700 Ω
1-23	.10	27 K Ω
1-27	.10	150 K Ω

1/2 Watt 5%

1-130	.10	8.2 Ω
1-54	.10	15 Ω
1-136	.10	160 Ω
1-137	.10	200 Ω
1-80	.15	1200 Ω

2 Watt 10%

1-19-2	.20	1200 Ω
1-17-2	.20	6800 Ω

2 Watt 5%

3-2-2	.25	.33 Ω
3-1-2	.25	.82 Ω
3-3-2	.25	2.7 Ω

Precision 1/2 Watt 1%

2-94	2.10	.1 Ω
2-130	2.30	.2 Ω
2-163	.75	.7 Ω
2-229	.70	2.0 Ω
2-259	.25	97 Ω
2-165	.20	4950 Ω
2-50	.20	10 K Ω
2-166	.20	35 K Ω

Other Resistors

3-1-5	.15	2500 Ω 5% 7 watt wire-wound resistor
9-9	1.55	500 Ω thermistor

PART No.	PRICE Each	DESCRIPTION
-------------	---------------	-------------

CAPACITORS

21-16	.10	.01 μ fd disc
27-34	.25	.2 μ fd resin
25-56	.45	100 μ fd electrolytic, 10 V
25-128	.95	100 μ fd electrolytic, 50 V
25-131	.90	250 μ fd electrolytic, 25 V
25-121	1.35	500 μ fd electrolytic, 50 V
25-177	4.20	3000 μ fd electrolytic, 75 V
25-178	1.75	100-40-40 μ fd electrolytic

WIRE-WOUND CONTROLS

11-77	1.25	30 Ω
11-76	1.25	240 Ω
11-74	.70	50 Ω
11-44	.45	1000 Ω

SWITCHES

63-437	2.40	4-position 2-wafer rotary
63-438	5.00	11-position 4-wafer rotary
60-20	.55	TPDT slide
60-34	.85	TPDT rocker
61-9	1.20	SPST toggle (with two 1/2" nuts and a lockwasher)

TRANSISTORS-DIODES

417-20	2.70	2N2553/R265A/2N1039-1 transistor
417-141	3.15	2N2869/2N301 transistor
417-142	5.00	DTG-600 transistor
57-27	.60	Silicon diode
56-13	1.10	56 V zener diode
56-68	1.50	68 V zener diode
56-48	3.15	110 V zener diode

SOCKETS-TERMINAL STRIPS-FUSEHOLDER

434-102	.15	Small transistor socket
434-117	.20	Large transistor socket
431-50	.10	1-lug terminal strip
431-51	.10	2-lug terminal strip
431-41	.10	2-lug terminal strip
431-5	.10	4-lug terminal strip
431-11	.10	5-lug terminal strip
431-45	.10	6-lug terminal strip
431-35	.10	7-lug terminal strip
422-1	.25	Fuseholder

<u>PART No.</u>	<u>PRICE Each</u>	<u>DESCRIPTION</u>	<u>PART No.</u>	<u>PRICE Each</u>	<u>DESCRIPTION</u>
INSULATORS-GROMMETS			#8 Hardware		
75-60	.10	Mica insulator	250-137	.05	8-32 x 3/8" screw
75-88	.10	Transistor insulator case	254-2	.05	#8 lockwasher
481-3	.10	Capacitor mounting wafer	252-4	.05	8-32 nut
73-45	.10	1/2" grommet			
75-71	.10	Line cord strain relief, flat			
WIRE HARNESS-WIRE-SLEEVING			Other Hardware		
134-151	3.15	Wire harness	253-10	.05	Control washer
344-2	.05/ft	Large black wire	254-4	.05	Control lockwasher
344-3	.05/ft	Large red wire	259-10	.05	Control solder lug
344-31	.05/ft	Large brown wire	252-7	.05	Control nut
344-50	.05/ft	Small black wire	252-32	.05	Push-on speednut
344-52	.05/ft	Small red wire			
344-54	.05/ft	Small yellow wire			
344-56	.05/ft	Small blue wire			
340-2	.05/ft	Bare wire			
346-1	.05/ft	Sleeving			
HARDWARE			METAL PARTS		
#2 Hardware			Chassis-Cabinet Parts		
250-175	.05	2-56 x 3/8" screw	203-476	1.20	Front panel
254-7	.05	#3 lockwasher	203-477	1.35	Rear panel
252-51	.05	2-56 nut	200-484	1.15	Chassis
			204-767	.40	Siderail
			204-759-1	.10	End cap
			90-350-2	3.40	Cabinet half shell
			210-35	3.75	Bezel
#6 Hardware			Other Metal Parts		
250-229	.05	6-32 x 1/4" phillips head screw	205-545	.20	Heat sink plate
250-303	.20	6-32 x 1/4" decorative screw	204-565	.10	Relay mounting bracket
250-270	.05	6-32 x 3/8" black screw	207-2	.20	Capacitor mounting clamp
250-89	.05	6-32 x 3/8" screw	260-24	.30	Diode clip
250-26	.05	6-32 x 5/8" screw			
250-304	.15	6-32 x 3/8" stud			
250-227	.05	6-32 x 7/8" phillips head screw			
250-365	.05	#6 x 1/4" sheet metal screw			
254-1	.05	#6 lockwasher			
259-1	.05	#6 solder lug			
253-1	.05	#6 flat fiber washer			
253-2	.05	#6 shoulder fiber washer			
255-13	.05	#6 x 1/4" spacer			
255-15	.05	#6 x 1/2" spacer			
255-1	.05	Insulator case spacer (thick)			
255-74	.10	Insulator case spacer (thin)			
252-3	.05	6-32 nut			
			MISCELLANEOUS		
			Electrical Components		
			54-180	10.60	Power transformer
			69-13	3.40	Relay
			407-120	8.60	Meter
			412-15	.15	Neon lamp
			413-10	.10	Red lens
			413-14	.30	Amber lens
			421-25	.30	1-1/2 ampere slow-blow fuse
			89-23	.80	Line cord
			432-27	.40	Line cord adapter



<u>PART</u> <u>No.</u>	<u>PRICE</u> <u>Each</u>	<u>DESCRIPTION</u>
---------------------------	-----------------------------	--------------------

Other Components

211-33	.40	Handle
462-245	.60	Knob
455-50	.10	Knob bushing
427-3	.15	Binding post base
75-17	.10	Binding post bushing
100-16-2	.10	Binding post cap (black)
100-16-18	.10	Binding post cap (red)

<u>PART</u> <u>No.</u>	<u>PRICE</u> <u>Each</u>	<u>DESCRIPTION</u>
---------------------------	-----------------------------	--------------------

Other Components (cont'd.)

261-28	.10	Stick-on rubber foot
261-30	.10	Line cord retainer
490-5	.10	Nut starter
352-13	.15	Silicone grease
331-6	.15	Solder
	2.00	Manual (See front cover for part number.)

The above prices apply only on purchases from the Heath Company where shipment is to a U.S.A. destination. Add 10% (minimum 25 cents) to the price when ordering from an authorized Service Center or Heathkit Electronic Center to cover local sales tax, postage and handling. Outside the U.S.A. parts and service are available from your local Heathkit source and will reflect additional transportation, taxes, duties and rates of exchange.

LIMITER BIAS POWER SUPPLY

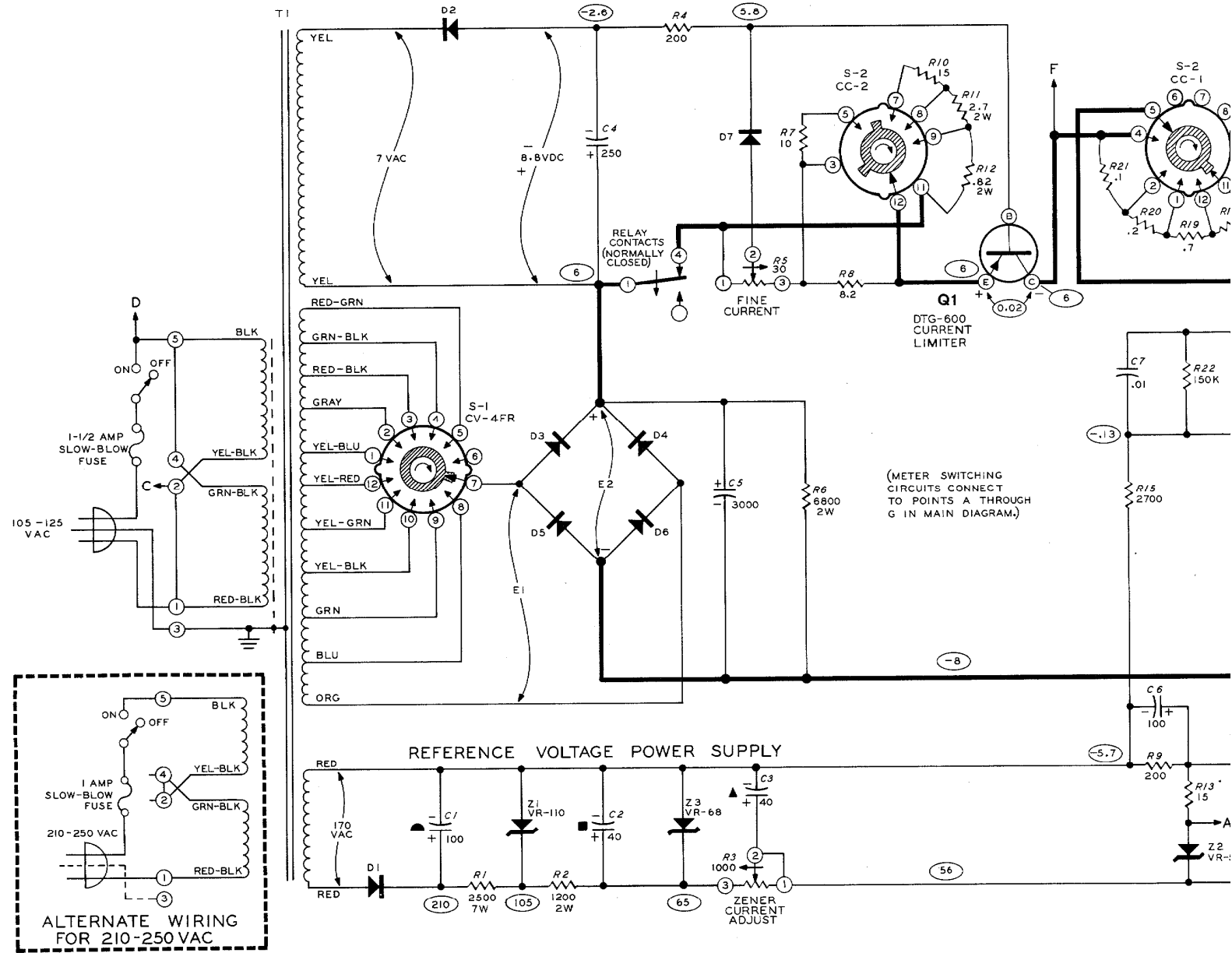

NOTES:

- ALL RESISTORS ARE 1/2 WATT UNLESS OTHERWISE MARKED.
- ALL CAPACITORS ARE IN μ fd.
- \ominus INDICATES A DC VOLTAGE MEASUREMENT FROM POINT INDICATED TO NEGATIVE (-) OUTPUT TERMINAL.
- ALL VOLTAGES WERE MEASURED WITH NO LOAD ON THE OUTPUT TERMINALS WITH 117 VAC 60 Hz INPUT.
- ALL VOLTAGES WERE MEASURED WITH A VTVM, AND MAY VARY $\pm 10\%$.
- ALL SWITCHES ARE SHOWN IN THE FULLY COUNTERCLOCKWISE POSITION, AS VIEWED FROM THE KNOB END OF THE SHAFT.
- ARROWS ON CONTROLS AND SWITCHES INDICATE CLOCKWISE ROTATION.
- CONTROLS AND SWITCHES ARE SET AS FOLLOWS FOR VOLTAGE MEASUREMENTS:

COARSE VOLTAGE - .5-5 VOLTS
 COARSE CURRENT - 1.5A
 FINE VOLTAGE - MAX. CLOCKWISE
 FINE CURRENT - MAX. CLOCKWISE
 RESET-STANDBY - RESET-STANDBY
 CURRENT-VOLTAGE SWITCH - VOLTAGE
 ZENER CURRENT SWITCH - NORMAL

- ROTARY SWITCHES ARE SHOWN IN MAXIMUM COUNTERCLOCKWISE POSITION, AND ARE MARKED AS IN THE FOLLOWING EXAMPLE:

CV MEANS THIS IS A PART OF THE COARSE VOLTAGE SWITCH. THIS NUMBER INDICATES THE SWITCH WAFER AS COUNTED FROM THE FRONT PANEL.
 F = FRONT R = REAR FR = FRONT AND REAR

POSITION OF CV SWITCH	E1 VOLTS AC	E2 VOLTS DC	E3 VOLTS DC
.5-5	10	14	6
5-10	15	21	10
10-15	20	28	15
15-20	25	35	20
20-25	29	41	25
25-30	33	47	30
30-35	38	54	35
35-40	43	60	40
40-45	47	68	45
45-50	53	74	50

Set controls and switches as in NOTES except for Coarse Voltage switch.

SCHEMATIC OF HEATHKIT[®] REGULATED L.V. POWER SUPPLY MODEL IP-27

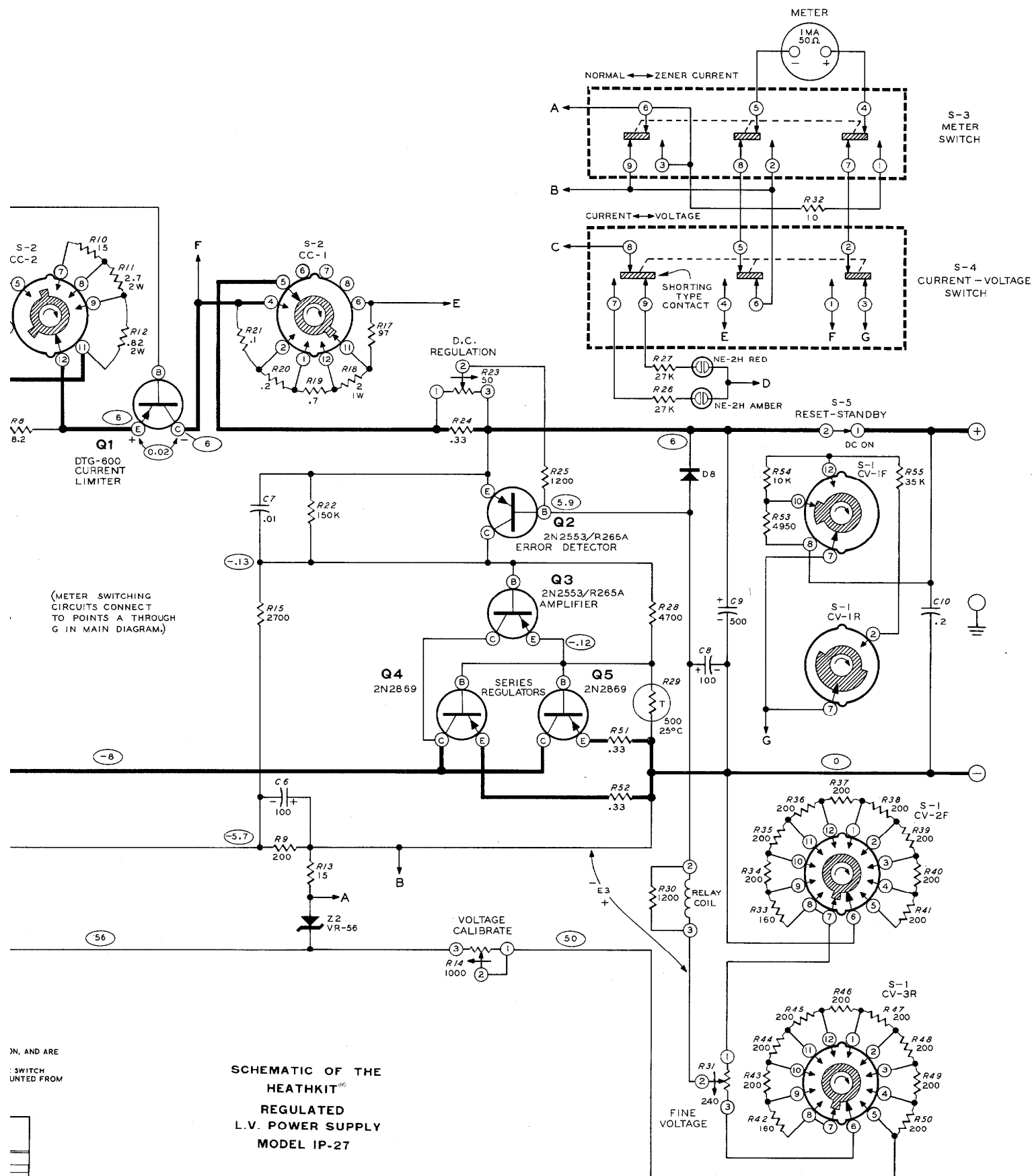

**SCHEMATIC OF THE
 HEATHKIT[®]
 REGULATED
 L.V. POWER SUPPLY
 MODEL IP-27**

SCHLUMBERGER PRODUCTS CORP.

SERVICE BULLETIN

TO: ALL STORES	FROM: Robert W. Furcaw
SUBJECT: IP-27	DATE: June 24, 1971
	BULLETIN NO: IP-27-1

REPEAT TRANSISTOR FAILURE WHEN VOLTAGE SWITCH IS ROTATED RAPIDLY

Install zener and capacitor from collector of Q4 and Q5 to neg output terminal. See inserts. This should be installed in all units serviced.

PARTS USED:

- 1 56-13 VR 56
- 1 27-107 .015 600V

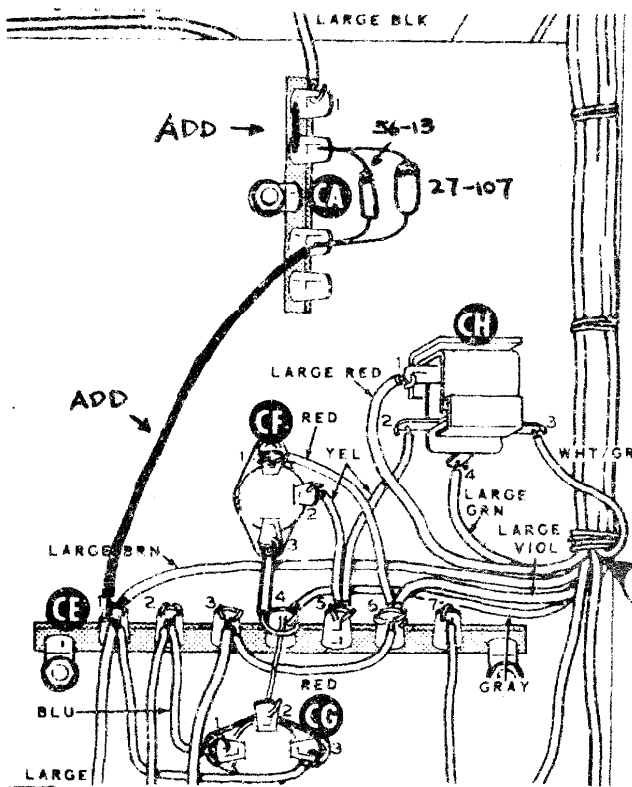

RWF
RWF:vb

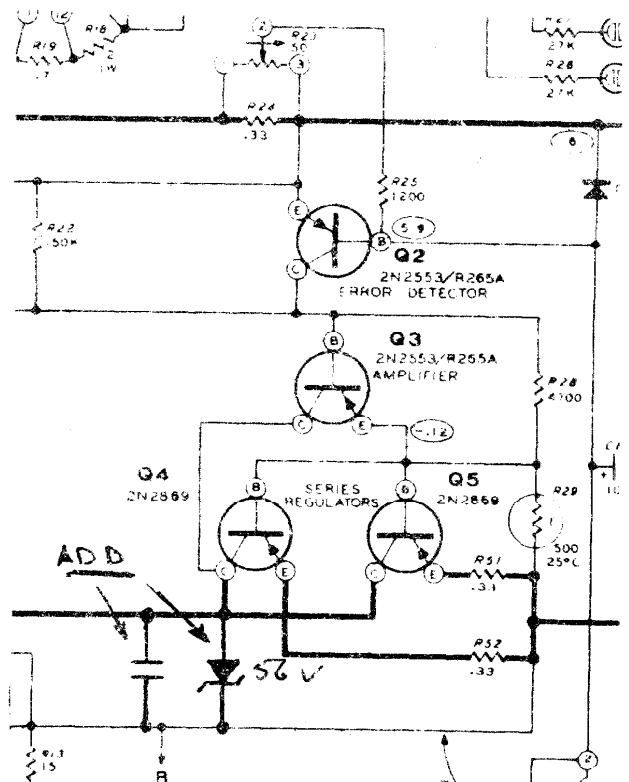

HEATH COMPANY

BENTON HARBOR, MICHIGAN

THE WORLD'S FINEST ELECTRONIC EQUIPMENT IN KIT FORM

LITHO IN U.S.A.